

# Bldc Motor BD42

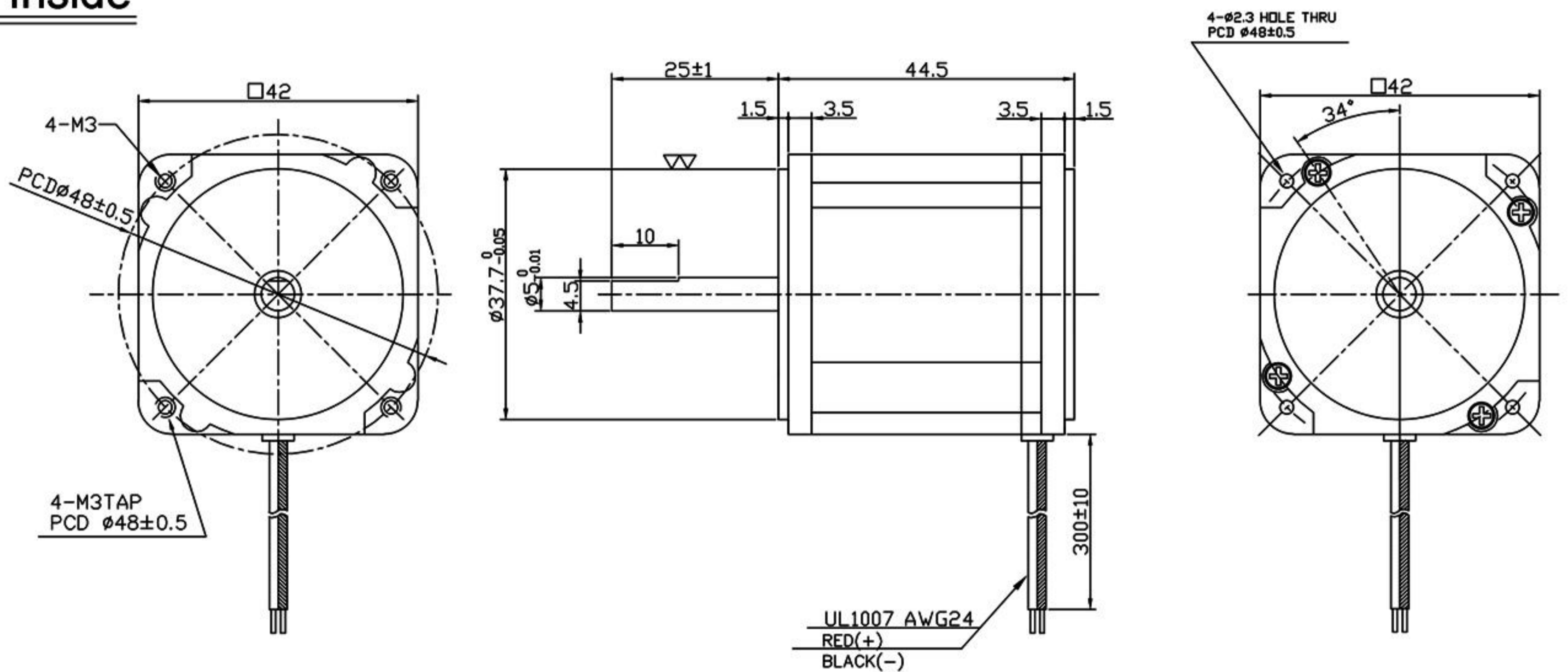

## DIMENSIONS

### Driver Inside



### Driver (SBDO-01)

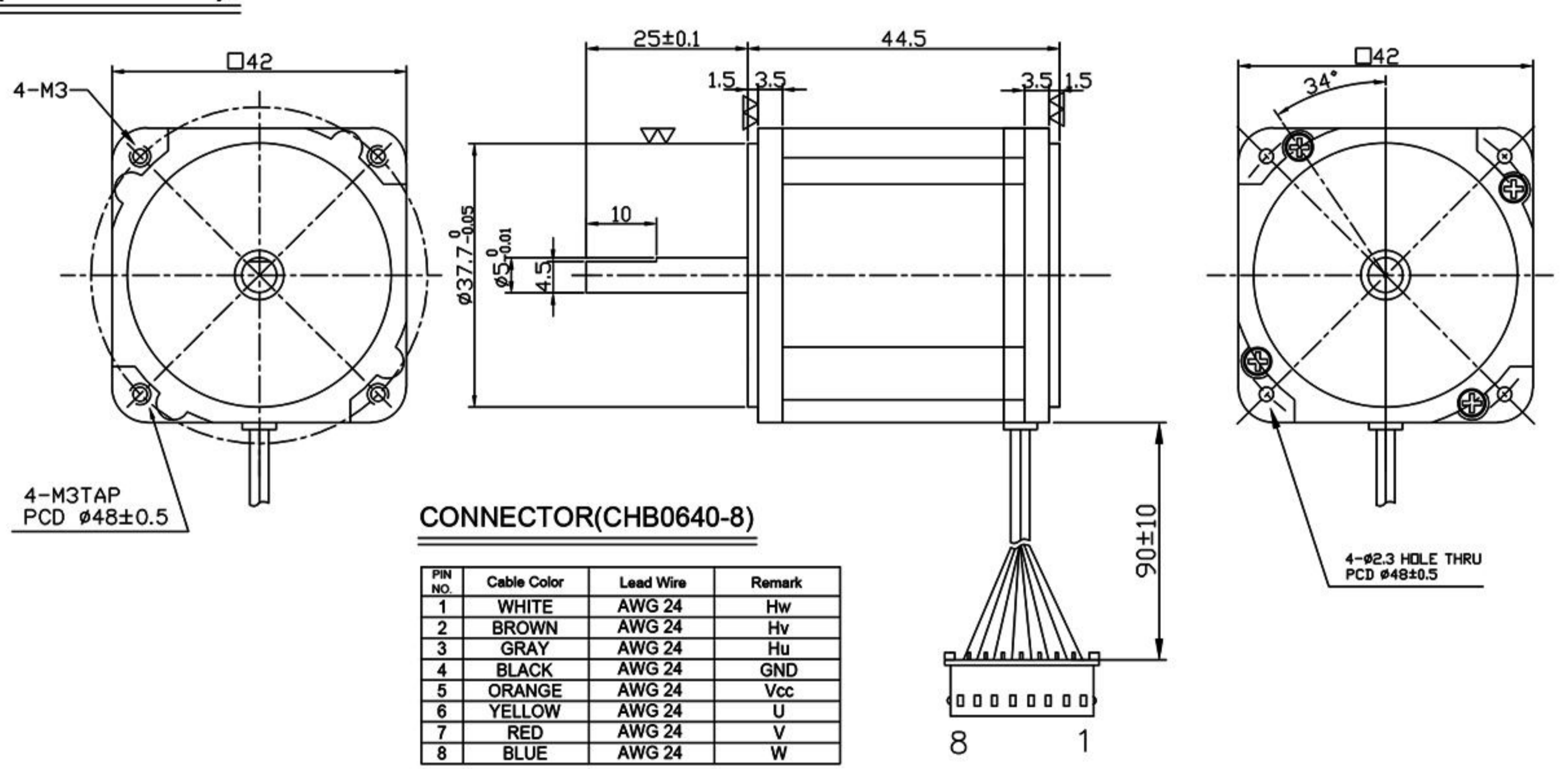

## SPECIFICATION

MODEL		BD42					
		I012005	I012007	I024007	F012005	F012007	F024007
Rated Voltage	V	12	12	24	12	12	24
Rated Output	W	5	7	7	5	7	7
Rated Current	A	1.0	1.0	0.5	1.0	1.0	0.5
Rated Speed	r/min	2000	2400	2400	2000	2400	2400
Rated Torque	kgf-cm	0.26	0.28	0.28	0.26	0.28	0.28
weight	kg	0.25	0.25	0.25	0.25	0.25	0.25
Applicable Driver		Driver Inside(내장형)			SBDO-01(외장형)		

내장형은 속도조절 불가능합니다.

## CHARACTERISTICS

BD42-I012005

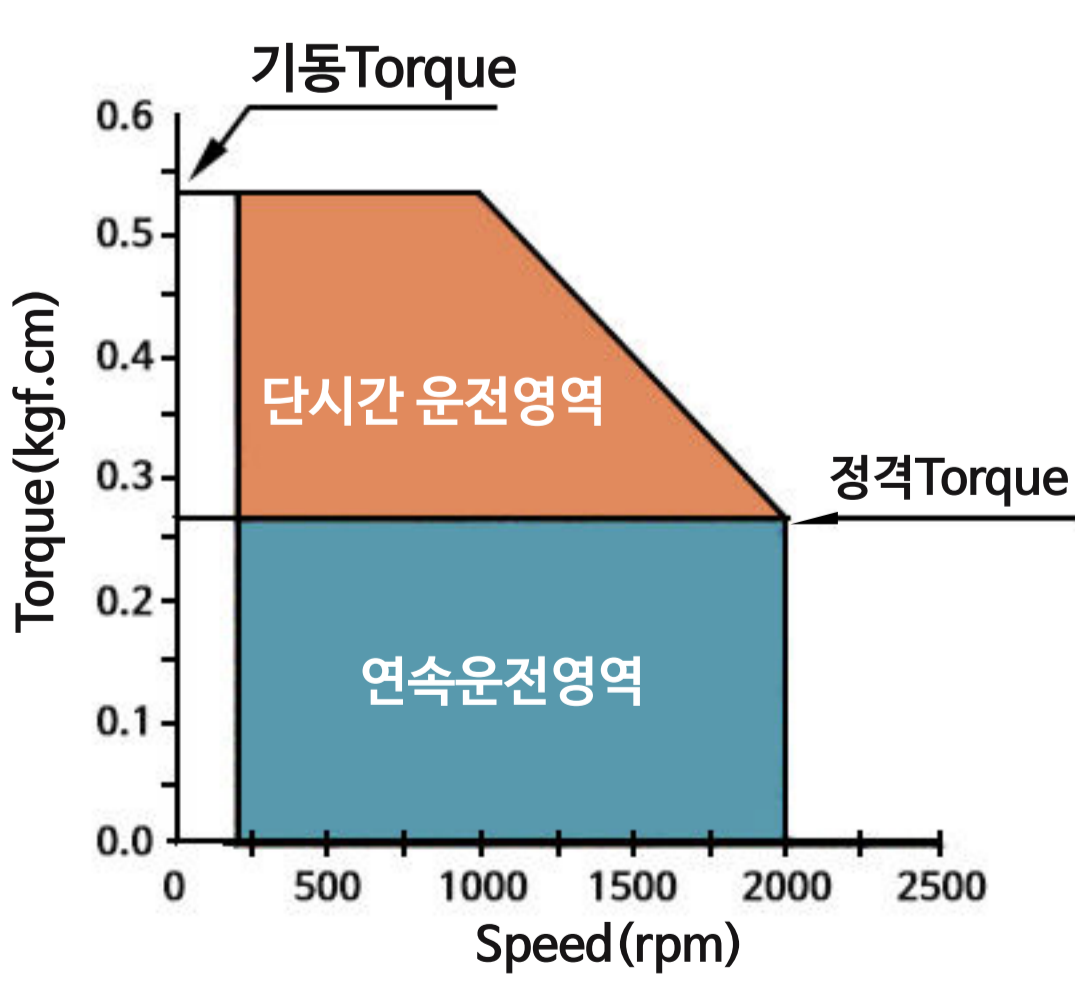

BD42-I012007

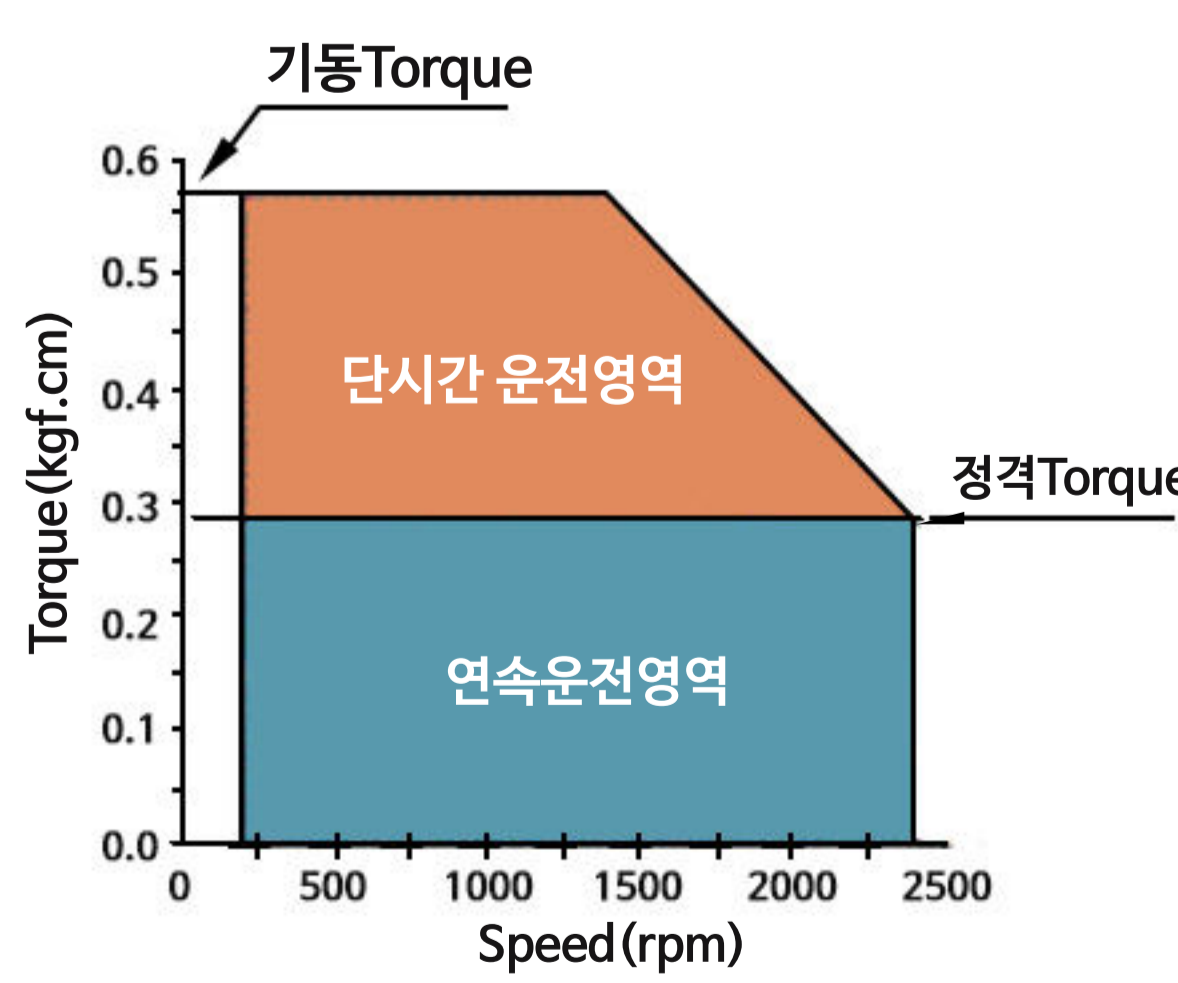

BD42-I024007

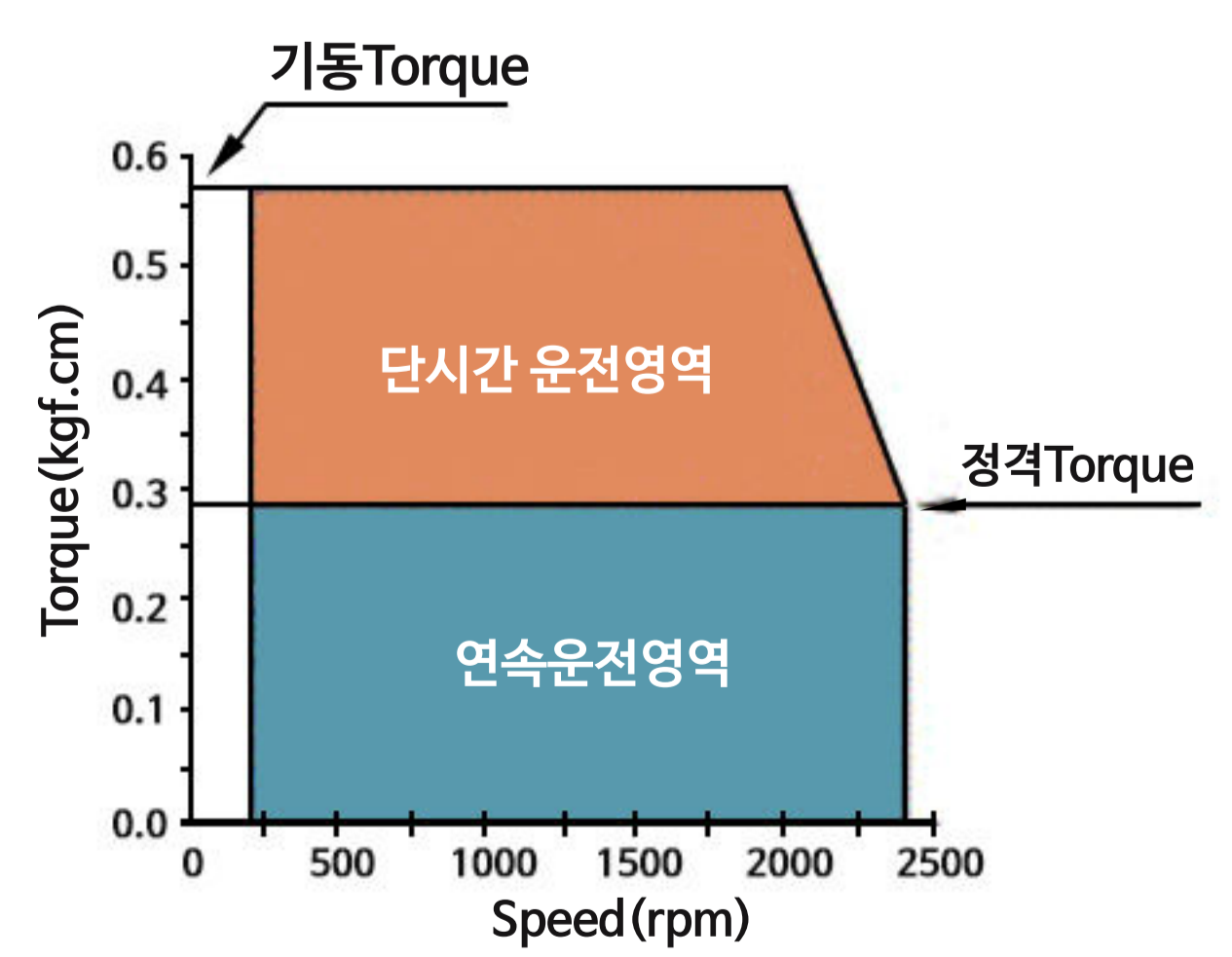

BD42-F012005

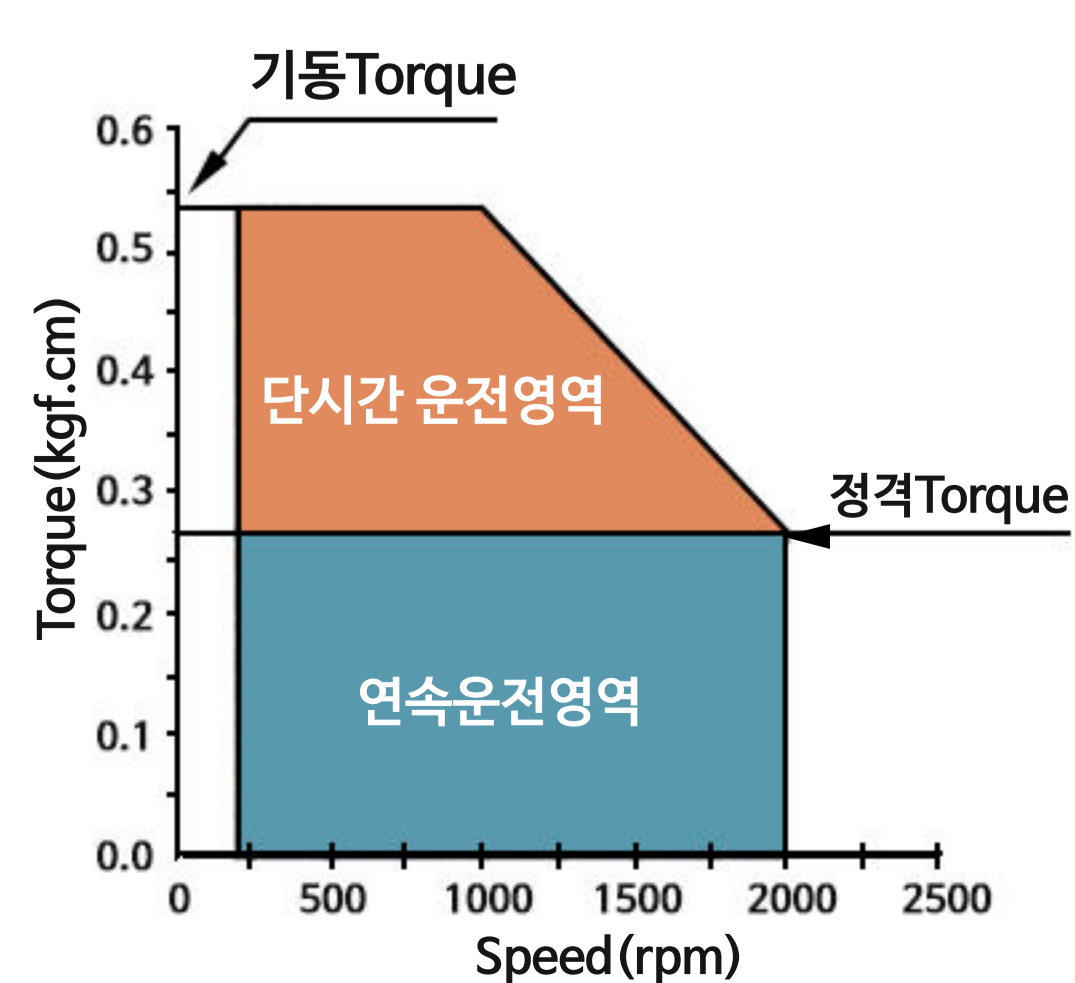

BD42-F012007

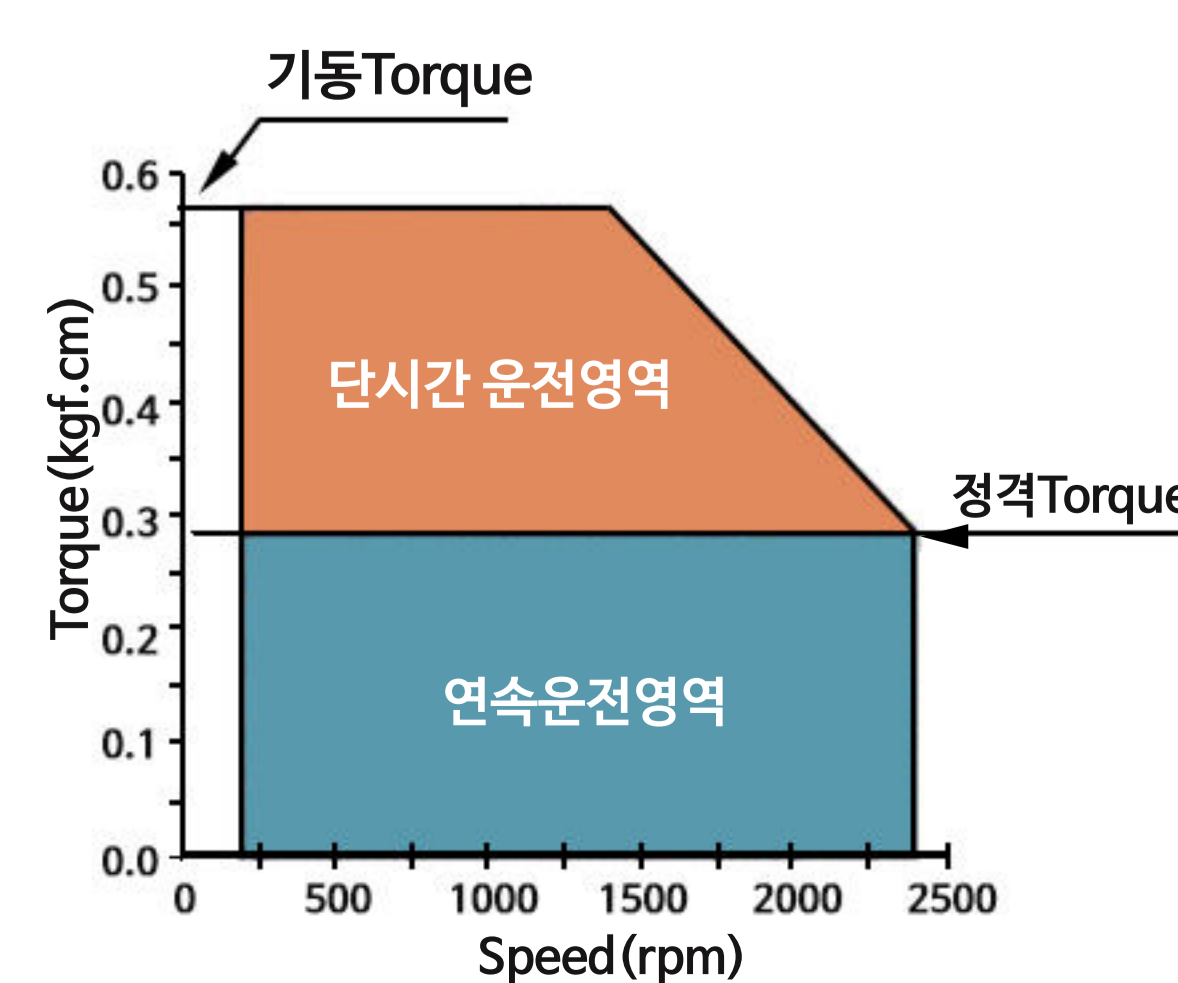

BD42-F024007

